

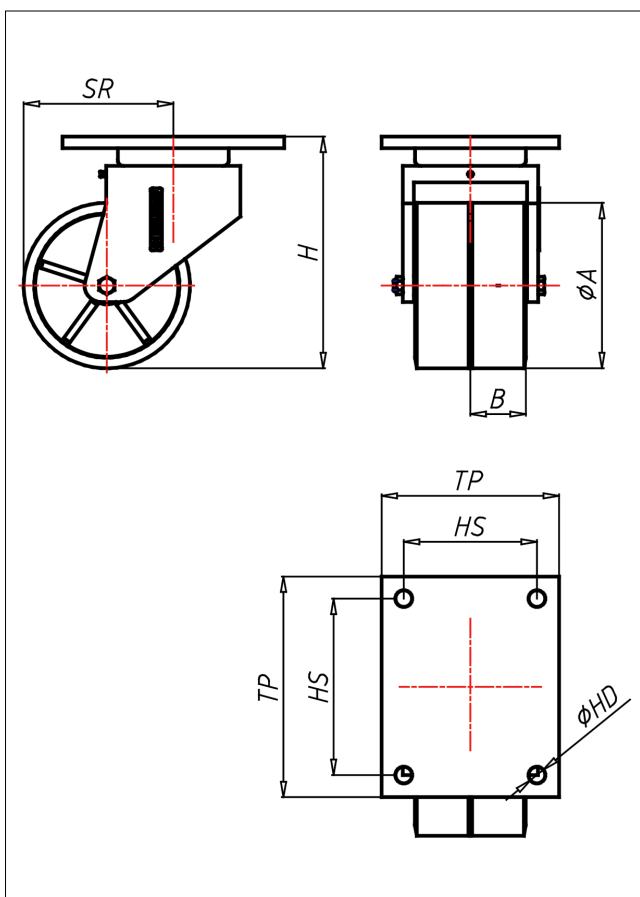

EDD/ES-ZK/ZZK

Lenkrolle

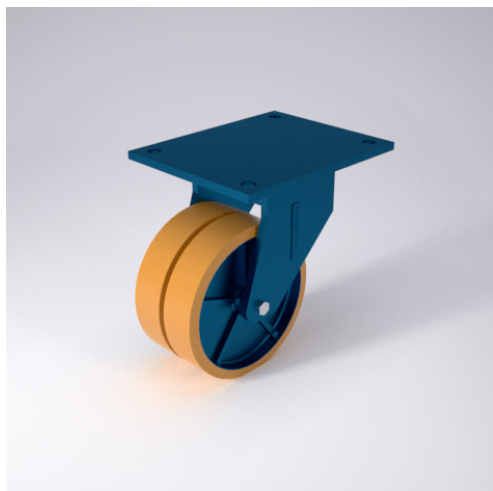

EDD-Z



LENKROLLE	Feststeller TLCH Seite 42	BOCKROLLE																				
<ul style="list-style-type: none"> geräuscharmer Lauf geringer Rollwiderstand abrieb- und reißfest hohe Stoßfestigkeit sehr beständig gegen viele aggressive Medien <p>Guss-Polyurethan Felge Gusseisen lackiert → Seite 245</p>	<p>Schrägrollen- und Axialkugellager, staubgeschützt, sehr starker Zentralbolzen, Mütter gesichert, Schmiemoppel Ausführung – lackiert → Seite 26</p>	<p>AUSWAHLHILFE:</p> <table border="0"> <tr> <td>leicht lenkend</td> <td><input type="radio"/></td> <td><input checked="" type="radio"/></td> <td><input type="radio"/></td> </tr> <tr> <td>verschleißarm</td> <td><input type="radio"/></td> <td><input checked="" type="radio"/></td> <td><input type="radio"/></td> </tr> <tr> <td>stoßfest</td> <td><input type="radio"/></td> <td><input checked="" type="radio"/></td> <td><input type="radio"/></td> </tr> <tr> <td>bodenschonend</td> <td><input type="radio"/></td> <td><input checked="" type="radio"/></td> <td><input type="radio"/></td> </tr> <tr> <td>witterungsbeständig</td> <td><input type="radio"/></td> <td><input checked="" type="radio"/></td> <td><input type="radio"/></td> </tr> </table>	leicht lenkend	<input type="radio"/>	<input checked="" type="radio"/>	<input type="radio"/>	verschleißarm	<input type="radio"/>	<input checked="" type="radio"/>	<input type="radio"/>	stoßfest	<input type="radio"/>	<input checked="" type="radio"/>	<input type="radio"/>	bodenschonend	<input type="radio"/>	<input checked="" type="radio"/>	<input type="radio"/>	witterungsbeständig	<input type="radio"/>	<input checked="" type="radio"/>	<input type="radio"/>
leicht lenkend	<input type="radio"/>	<input checked="" type="radio"/>	<input type="radio"/>																			
verschleißarm	<input type="radio"/>	<input checked="" type="radio"/>	<input type="radio"/>																			
stoßfest	<input type="radio"/>	<input checked="" type="radio"/>	<input type="radio"/>																			
bodenschonend	<input type="radio"/>	<input checked="" type="radio"/>	<input type="radio"/>																			
witterungsbeständig	<input type="radio"/>	<input checked="" type="radio"/>	<input type="radio"/>																			

Technische Details

ORDERNO (Artikel-nummer)	EDD 200 ZZK
WDAB (Rad-Ø A x Breite B / mm)	200x50+50
LC (Tragkraft / kg)	2000
H (Bauhöhe H / mm)	270
TP (Plattengröße / mm)	255x205
HS (Lochabstand / mm)	210x160
HD (Loch-Ø / mm)	17
SR (Schwenkradius / mm)	170
WB (Radlager)	Kugellager